



Vibration Comparator

VC-2100

The VC-2100 can serve as your vibration "watchdog" in a wide range of situations in which vibration-based judgments must be made, such as in go/nogo vibration testing of products, facilities diagnosis, and machine tool cutting tool damage.

Combined with an acceleration pickup, it provides a full range of functions, from vibration detection through measurement and diagnosis, in a single package.

ONO SOKKI

Introduction

The VC-2100 Vibration Comparator accepts the output from an acceleration pickup, and provides high-performance vibration level judgments, detection of abnormalities in machinery, and verification of vibration level. By performing simultaneous digital processing over two frequency bands, it enables detection, measurement, and judgment for each abnormal phenomenon.

Features

Compact 96 x 96 (DIN) Size

The VC-2100 was packaged for easy mounting into a control panel, with the functions of more than two units in this compact size, this representing less than 1/5 the space formerly required.

Comparator Delay Time Setting

A comparator output is made when the vibration exceeds a comparison level for more than a set period of time. This prevents misoperation caused by human errors, such as when an operator accidentally strikes a sensor.

Simultaneous Two-Band Judgment

Two frequency bands can be set, enabling a judgment based on the effective value or peak value on each band. Because the judgment is performed based on the vibration value, the achievement of more complex discrimination is facilitated.

Digital Display Function

In addition to displaying the vibration values digitally, a bar graph provides a visual presentation of the vibration condition, enabling use as needle-indicating vibration meter used in the past.

Analog Output

An AC signal and a DC signal are output for each set band, enabling use in combination with analysis equipment such as an FFT analyzer, and connection to a recorder.

Headphone Output

By connecting a pair of commercially sold headphones to the VC-2100, it is possible to make an auditory check of the vibration sound, enabling use of the VC-2100 as one would have used a stethoscopic probe in the past. Outputs are provided for each band, enabling a check for each phenomenon separately.

Comparator Gate Input

The VC-2100 can be used for automatic go/nogo product testing on a production line. By controlling the measurement timing it is possible to measure and diagnose vibrational phenomena of interest.

● Frequency Distribution of Abnormal Vibration from Machinery

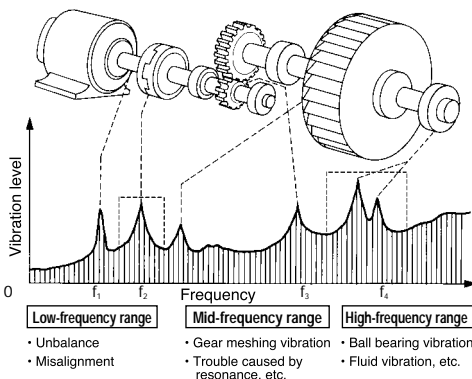

Frequency bands A and B are established from f_1 to f_2 and from f_3 to f_4 , respectively, by selecting frequencies f_1 through f_4 . The ability to use a variety of combinations facilitates a detection and measurement strategy that suits the phenomenon being observed. It is also possible to select diagnosis based on either the effective value or the peak value in each band individually.

Why Bands?

The frequency band in which vibration occurs depends on the nature of the phenomenon that causes the vibration. The VC-2100 uses digital filtering to set the frequency band in which particular types of vibration might occur, thereby enabling independent monitoring and diagnosis for each phenomenon.

VIBRATION COMPARATOR VC-2100

Application Examples

The VC-2100 can be used in a wide variety of applications, thereby greatly expanding your capabilities for *shipping inspection, facilities diagnosis, and trouble detection.*

Go/nogo Diagnosis Based on Product Vibration Values

(Example)

It is possible to perform a go/nogo test of bearings based on vibration values.

The bearing is rotated and the diagnosis is made based on the resulting bearing vibration. By noting the vibration in a particular frequency band, it is easy to detect particular problems in bearings, such as damage, foreign matter, and unbalance). In addition to an acceleration pickup, it is possible to use a velocity pickup as the sensor. When using a velocity sensor, the VC-2100 is switched to external signal input.

Related Fields

- Electric home appliances (e.g., washing machines, air conditioners)
- Automotive (e.g., power seats, door mirrors)
- Other product manufacturing (e.g., motors, gears, bearings)

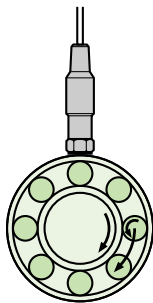

Inspection of Abnormal Operation in Machinery

(Example)

It is possible to detect abnormal operation of the main shaft of machine tools.

The runout of the main shaft of a machine tool greatly affects the accuracy of a machined workpiece. While the conventional method of measuring main shaft runout is that of using a displacement indicator, environmental and operating conditions and cost make the use of this approach difficult. The VC-2100, with its ability to detect abnormal main shaft vibration, provides a method that is immune to environmental conditions and which can be used for continuous monitoring.

When the main shaft runout becomes large, the vibration value also increases, enabling main shaft runout problems to be detected by detecting vibration.

Related Fields

- Machine tool manufacturing and machining

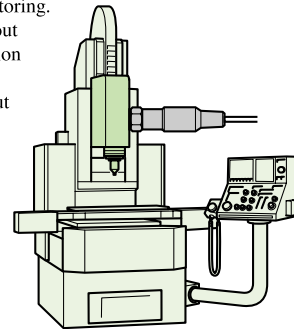

Facilities Diagnosis

(Example)

It is possible to gain a grasp of and detect abnormalities in bearings and gears of production facilities without the need for human intervention.

In facilities diagnosis in the past, the approach taken was that of periodically performing vibration measurements of such components as bearing boxes to determine when maintenance should be done, based on changes in the measured vibration values, this process being highly labor-intensive. In addition, suddenly occurring problems under this system could cause damage to equipment.

Using the VC-2100, a vibration comparator takes the place of the human operator, and performs constant monitoring of vibration, thereby enabling a great reduction in labor, while contributing to the prevention of damage to equipment when problems occur.

The ability to arbitrarily select frequency bands further enhances the diagnosis precision.

Related Fields

- Steel
- Chemical plants
- Other production line facilities management

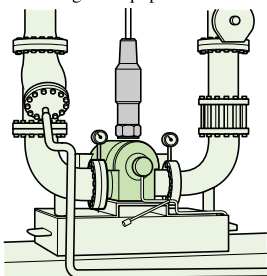

Detection of Tool Breakage and Wear

(Example)

It is possible to detect breakage of drills and bites used on a machine tool without human intervention.

Machine tools used for mass production of parts run almost completely unattended by operators. If a drill or other cutting tool breaks during this type of unattended operation, bad production can result, thereby requiring reworking. In the worst case, the product might even need to be discarded.

The VC-2100 Vibration Comparator detects the vibration occurring when a cutting tool breaks and stops the machine, thereby minimizing the resulting production of bad workpieces. Because a worn cutting tool results in poor machining precision, by monitoring the change in vibration values caused by tool wear, it is possible to improve machining precision.

Related Fields

- Parts machining
- Machine tool manufacturing
- Monitoring on a machining line

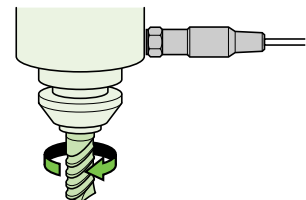

Total Support for Detection, Measurement, and Diagnosis

(Simultaneous Two-Band Processing) Detects bearing damage and wear in a single pass.

Compact Size: 96 x 96 mm DIN Panel

The performance of more than two units have been housed in a space that is less than 1/5 that formerly required.



Measurement: Digital and Bar-graph Display of Vibration Values

High-accuracy analysis is performed in accordance with analysis conditions, and a display is presented of vibration values and vibration condition (bar-graph display). By displaying measurement screens for each band separately, it is possible to collect the required data.

Provides Essential Sophisticated Features

Measurement and diagnosis of vibration is a complex process, and demands highly precise results. The VC-2100 provides that high-level of precision, enabling detailed conditions settings, in addition to meeting other tough measurement and diagnosis requirements.

Superb Diagnosis Capability Using Rms and Peak Values

The rms and peak values can be used for diagnosis in each band individually, enabling enhanced-precision diagnosis of complex machine vibrations.

Verification of Vibration Sound

By connecting a pair of conventional headphones, it is possible to monitor the vibration sound. An output is provided of the vibration sound for each band, enabling verification of particular vibration phenomena.



Direct Key Settings Enhances Ease of Operation

Frequently used conditions can be directly set, enabling the optimum settings to be made while observing the vibration condition.

- Measurement mode switching: Rms, Peak, Max hold (maximum rms value hold), Peak Hold (peak value hold)
- Measurement screen switching and band setting
- Bar-graph scale modification
- Input range setting: Optimum range setting to suit the vibration condition
- Comparator level setting: Setting is possible to suit a diagnosis criterion.

● Optional Functions

• Integration (VC-0251)

The signal from an acceleration pickup is integrated to enable measurement of velocity and displacement. This can be combined with the comparator function to perform diagnosis based on velocity and displacement criteria.

• Current output (VC-0253)

The analog DC output is converted to a 4-to-20-mA current output (voltage output is standard). This option is effective in remote sensing applications.

• Single Additional Band (VC-0252)

This option expands the VC-2100 to 3-band operation, enabling even more complex measurement and diagnosis applications.

Automated Data Collection With Less Labor

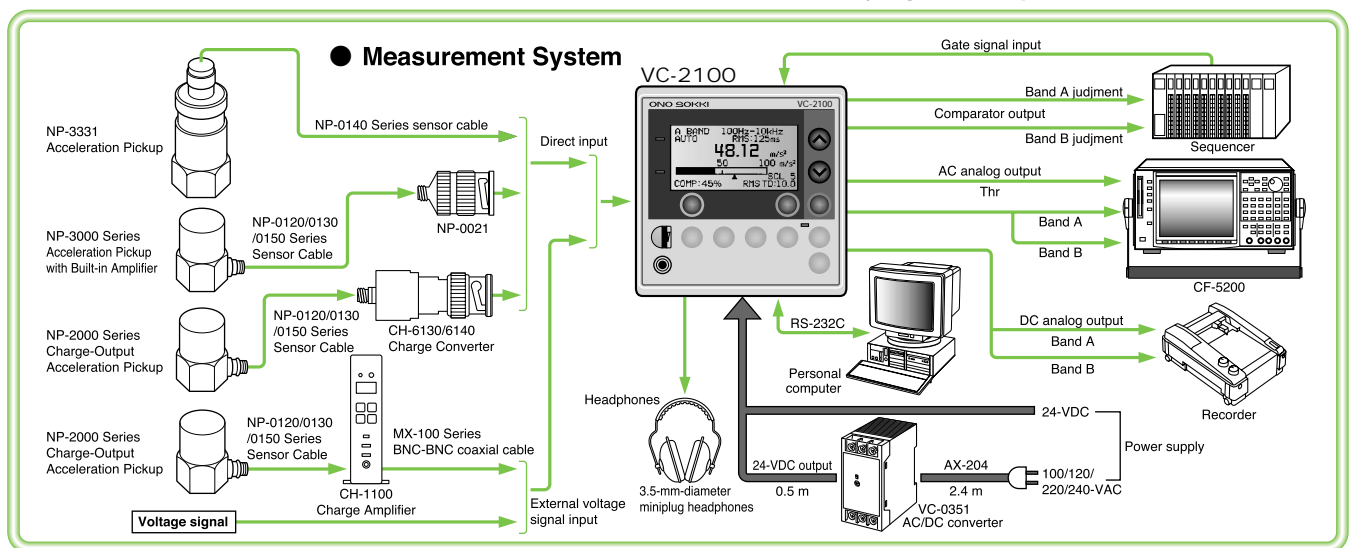
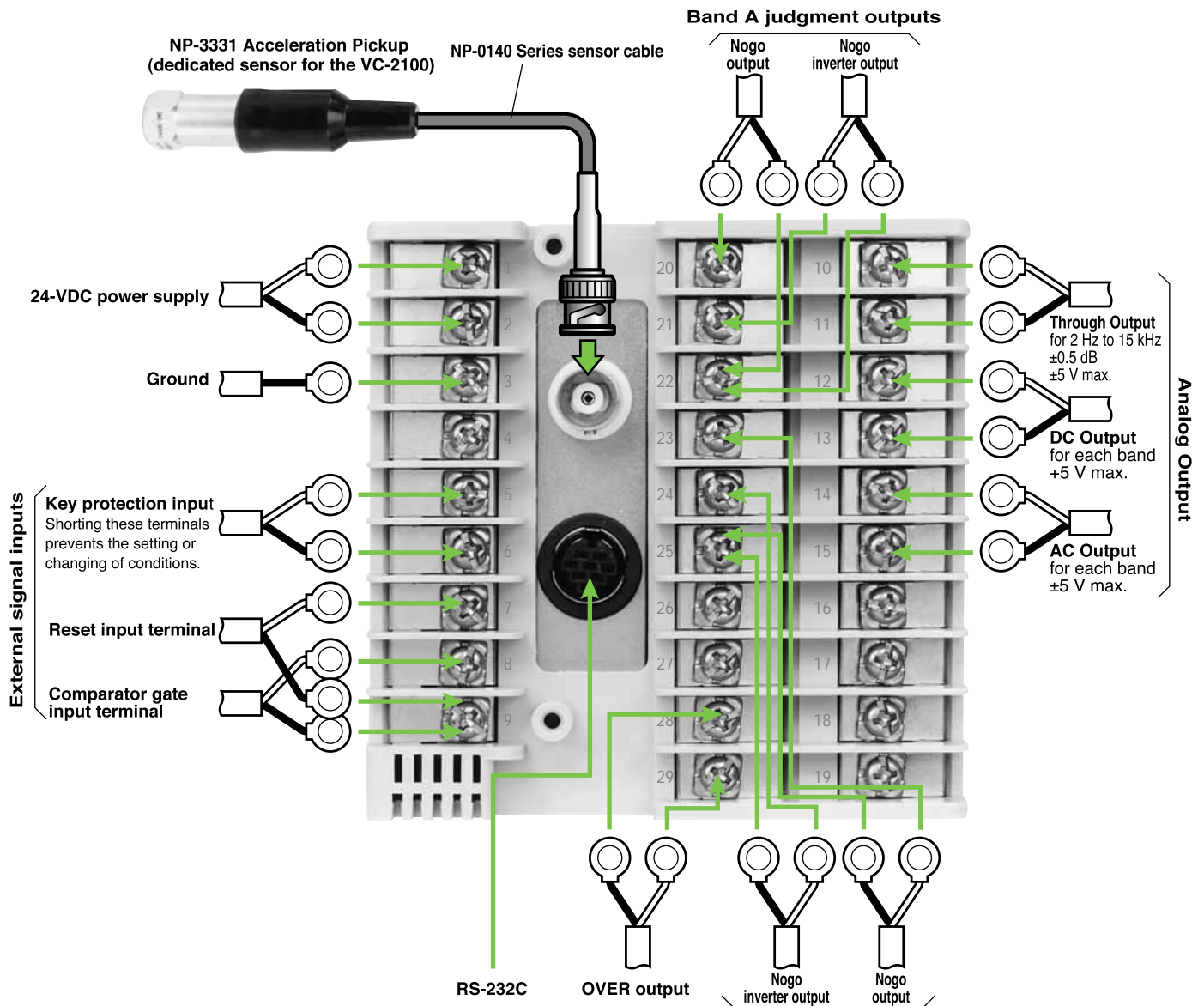

Accessories

NP-3331 Signal Cables

Model	Length	Appearance
NP-0143	5m	
NP-0144	10m	
NP-0146	20m	
NP-0148	30m	

*NP-0146 and NP-0148 are made-to-order specials.

Miniature/BNC Connector Adapter

Model	Outer Dimensions	Example of Use
NP-0021		<p>Signal cable NP-0120 Series NP-0130 Series</p> <p>NP-3000 Series Miniature connector</p> <p>Connected to VC-2100</p> <p>The VC-2100 sensor input has a BNC connector. To connect a sensor with a miniature connector to the VC-2100, the NP-0021 is required.</p>

Magnetic Base

Model	Outer Dimensions	Example of Use
NP-0100		<p>NP-3331</p> <p>NP-0100</p> <p>This is a magnetic base for the NP-3331. For details about using other NP Series acceleration pickups, refer to the NP/PS Series catalog.</p>

NP-3331 Acceleration Pickup

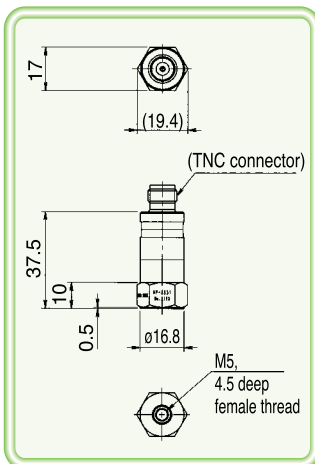

- Feature : Insulated
- Construction : Shear-type
- Sensitivity : 5.0 mV/(m/s²)±1 dB
- Resonant frequency : 25 kHz min.
- Frequency characteristics : 5 Hz to 4 kHz; ±0.5 dB
5 Hz to 8 kHz; ±3 dB
- Lateral sensitivity : 5% max.
- Maximum usable acceleration : 700 m/s²
- Maximum tolerable shock : 5000 m/s²
- Operating temperature range : -20 to +110°C
- Output impedance : 100 Ω max.
- Detector noise : 20 μV max.
- Drive power supply: 0.56 to 2 mA
- Weight : Approx. 49 g
- Case material : Stainless (SUS303)
- Outer dimensions : 17 mm x 37.5 H (mm)
- Connector : TNC connector (top)
- Detector mounting : M5, 4.5 deep female thread

NP-0143 Sensor Cable

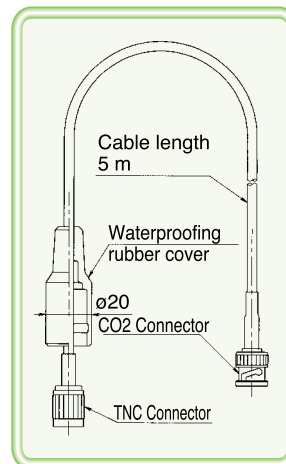

- Capacitance : 75 pF/m
- Insulation resistance : 1000 MΩ
- Operating temperature range : -20 to +110°C
- Cable outer diameter : 4.2 mm
- Material : FEP
- Waterproofing rubber cover : NBR
- Sensor connector : TNC
- Amp connector : CO2 (BNC)
- Cable length : 5 m

Specifications

■ VC-2100 Main Unit

■ Input Section

- Number of input channels : 1
- Signal input : Input switched between an acceleration pickup with a built-in amplifier and an external voltage signal.
 - *Acceleration pickup with built-in amplifier: 2 mA/18 VDC sensor power supply (constant current)
 - *External voltage signal: Input voltage; ± 5 V Input impedance; 100 k Ω min.
 - *Input connector: CO2 (BNC)
- Sensor sensitivity setting : 1.00 x 10⁻² to 9.99 x 10² mV/(m/s²), digital input
- Units setting : m/s² or engineering units
- Input ranges : 0.1 to 50000 m/s² (setting range depends on the sensor sensitivity) (Ex.: 2.000 to 1000 m/s² for a sensor sensitivity of 5 mV/(m/s²))
- Frequency characteristics : 3 Hz to 15 kHz: ± 0.5 dB
1.5 Hz to 20 kHz: ± 3 dB
- Input-referenced noise : 3 Hz to 20 kHz band: 30 μ Vrms

■ External Control Signal Input

- Functions : Key lock, reset input, gate input
- Input voltage : High: +4.2 to 5.0 V
Low: 0 to +0.8 V
- Dry voltage input : Open voltage: 5 V
Short-circuit current: 0.5 mA

■ Analysis Section

- Number of settable bands : 2 (3-band as an option of VC-0252)
- Band filters : HP filter: Thru, 100, 300, 500, 1 k, 3 k, 5 k, 10 kHz
LP filter: Thru, 100, 300, 500, 1 k, 3 k, 5 k, 10 kHz
Rolloff: -48 dB/oct (Butterworth, -3 dB \pm 1 dB at fc)
- Analog filters : Low-cut (highpass) filter: 10 Hz; -3 dB \pm 1 dB at fc, -18 dB/octave rolloff
High-cut (lowpass) filter: 1 kHz-10 kHz; -3 dB \pm 1 dB at fc, -18 dB/octave rolloff
Note) fc: cut off frequency

■ Processing Section

- Measurement modes: Switchable between rms value, peak value, maximum hold, and peak hold. Calculation and display made for each band separately.
 - *Rms value: True rms value
Time constant; Selectable as FAST (0.125 s), MID (0.25 s) or SLOW (1s).
 - *Peak value: Absolute PEAK value of time-axis waveform
 - *Maximum hold: Held maximum of rms value
 - *Peak hold: Held maximum of peak value

■ Output Section

- Analog output : Thru, AC and DC outputs (simultaneous)
 - *Output impedance: 100 Ω max.
 - *Thru output:
 - Maximum rated output; ± 5 V
 - Frequency range; 3 Hz to 15 kHz ± 0.5 dB
 - 1.5 Hz to 20 kHz ± 3 dB
 - *AC output:
 - Switchable output for each band
 - Maximum rated output; ± 5 V
 - Frequency range; 2 Hz to 15 kHz ± 0.5 dB
 - 0.8 Hz to 20 kHz ± 3 dB
 - *DC output:
 - Switchable output for each band

Maximum rated output; +5 V

4-20mm(Option)

※ In case of selecting the 4-20mA output function, the voltage signal can not be output.

- Headphone output : AC output for each band
 - *Power consumption: 15 mW into the rated impedance of 24 Ω
 - *Connector: 3.5-mm-diameter miniplug
- CAL signal output : 160 Hz, 1 V_{0-p} $\pm 3\%$ (output at AC output)
- RS-232C output : Provided as standard.
 - *Transmission rate: 9600 bps
 - Connector; HR12-10R-8 SD (Hirose) or equivalent
 - *Cable: AX-5021(25-pin Dsub connector)
AX-5022(9-pin Dsub connector)
- Over output : Output when input range or A/D range is exceeded. Open-collector output (negative logic)
 - *Voltage: DC30V max.
 - *Sinking current: 25 mA max.

■ Comparator Output

- Functions : Judgments made independently for each band
Selection of either rms or peak value judgment for each band.
- Comparator level setting : Settable in steps of 1% of the full-scale range
- Output : Outputs made when the measured value is above or below a set value.
Open-collector output (positive and negative logic outputs made simultaneously)
 - *Voltage: DC30V max.
 - *Sinking current: 25 mA max.
- Operating time : 100 ms max.
- Delay time setting : Selectable from 0, 0.5, 1, 1.5, 2, 3, 4, 5, 6, 7, 8, 9, 10, 15, and 20 seconds

■ Display

- Display type : Backlit LCD
 - *Measured value: 4-digit digital display
 - *Display refresh: 0.5 s
 - *Bar-graph display
 - *Comparator level display
- OVER indicator : Lights red when the input range or A/D range is exceeded.
- NG (nogo) indicator : Lights red when a comparison result causes a Nogo output.
- Comparator on/off display : Lights green when the comparator function is operating.

■ Accuracy

- Total accuracy : $\pm 3\%$ at 160Hz

■ Other Specifications

- Setting conditions backup : Setting values are saved in memory when the power is switched off.
- Terminal strip : M3.5 free screw terminals

■ Accessories

- Panel mounting fixtures (2)

■ General Specifications

- Power requirements : 22 to 26 VDC
- Current consumption: 160 mA max. (at 25°C)
- Operating temperature range : 0 to +50°C
- Storage temperature range : -5 to +55°C
- Operating humidity range : 85% relative humidity max. (without condensation)
- Outer dimensions : 96 x 96 x 112mm (DIN)
- Material : 94V2 (flame-retarded polycarbonate)
- Weight : Approx. 500 g

Outer Dimensions

VC-2100

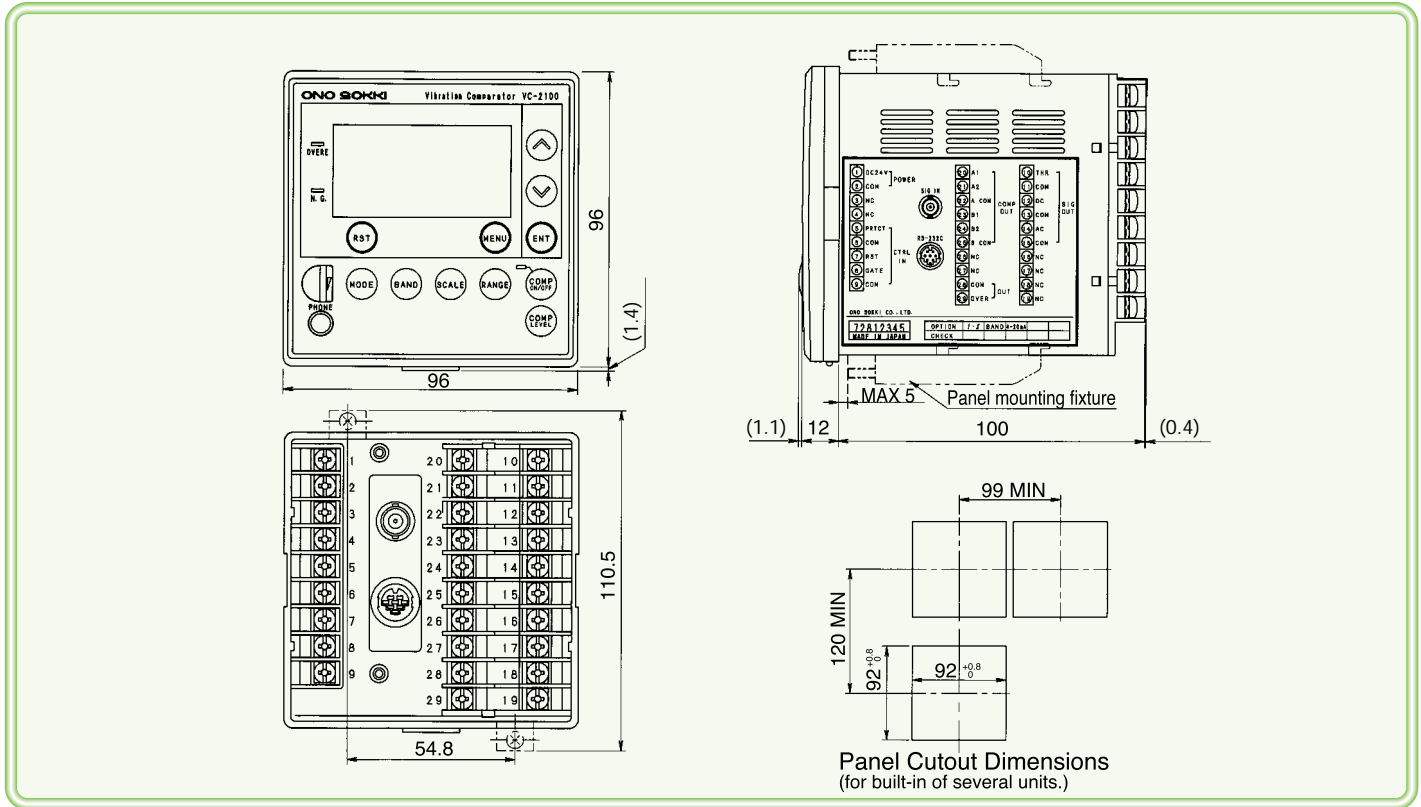

ONOSOKKI

U.S.A. & CANADA

Ono Sokki Technology Inc.
2171 Executive Drive, Suite 400
Addison, IL. 60101
U.S.A.
Phone: 630-627-9700
Fax : 630-627-0004

EUROPE

Ono Sokki Mess-und
Kontrollsysteme GmbH
Im Vogelsang 1, D-71101 Schoenaich
Germany
Phone: 07031-630203
Fax : 07031-654249

P.R.CHINA

Ono Sokki Beijing Office
Beijing Jing Guang Center 3510
Hu Jia Lou, Chao Yang Qu
Beijing P.R.C. 100020
Phone: 010-6597-3113
Fax : 010-6597-3114

WORLDWIDE

Ono Sokki Co., Ltd.
1-16-1 Hakusan, Midori-ku,
Yokohama 226-8507, Japan
Phone: 045-935-3976
Fax : 045-930-1906
E-mail: overseas@onosokki.co.jp

*Outer appearance and specifications are subject to change without prior notice.

HOME PAGE: <http://www.onosokki.co.jp/English/english.htm>